

Collection of recessed downlights for architectural applications. The luminaires are equipped with high performance Opti-Beam optics system for low luminance downlights (UGR < 10). Blade R is available in 3 aperture sizes, trim or trimless, 3 distributions, generous outputs of up to 3800 Lumens, and excellent chromatic performance (90CRI). The LC suitable for most ceiling conditions, retrofit or new construction, and they can also be installed in direct contact with insulation without needing a housing or thermal protection. The collection is paired with the industry best power supplies and can be down to 0.0%

**Luminaire characteristic:**

**Power input:** 9.8W to 27W (system wattage)  
**Lumens:** 575lm to 1760lm (for 3000K, 90CRI)  
**Luminaire efficacy:** Up to 83lm/W

**Source:** White LED (LM-80),  
2700K : 90CRI,  
3000K : 90CRI,  
3500K : 90CRI,  
4000K : 80CRI, 90CRI.  
**Lumen maintenance:** 80% of initial lumens at 50 000 hours (LM-79).

**Optic:** Low luminance Optic Beam technology with medium, flood and wide flood distribution.  
UGR < 10.

**Material:** Body: Die-cast aluminum  
Reflector: Metalized thermoplastic  
Baffle: Polycarbonate

**Mounting:** Remodel or new construction with plaster frame,  
See page 6 for details.

**Electrical:** See remote LED driver options on pages 3-5.

**Dimming:** Remote LED driver 0-10V, down to 0%.

**Finish:** See page 2 for details.

**Weight:** IBR06: 0.66 lbs (0.30 kg)  
IBR12: 1.19 lbs (0.54 kg)  
IBR18: 1.51 lbs (0.69 kg)  
IBR30: 2.75 lbs (1.25 kg)

**Warranty:** 5 year limited warranty.

**Rating:** IP20, IP23 (from under the ceiling).

**Certification:**  cULus listed for damp location. Interior use only.

**ORDERING INFO**

**IBR** - - **- LC -** - **- REM -**  
FIXTURE

**- BR** -  
PLASTER FRAME

\*Central cover always supplied in white. Black central cover can be ordered separately.

**MODEL**

**06** - Six       **12** - Twelve       **18** - Eighteen       **30** - Eighteen + twelve

**MOUNTING**

**TR** - Trim       **TL** - Trimless<sup>(1)</sup>

**INSTALLATION**

**RF** - Remodel (No plaster frame)       **NC** - New construction plaster frame

**LED**

**927** - 2700K, 90 CRI       **930** - 3000K, 90 CRI       **935** - 3500K, 90 CRI       **940** - 4000K, 90 CRI<sup>(1)</sup>       **840** - 4000K, 80 CRI

**OPTIC**

**MD** - Medium 24°       **FL** - Flood 40°       **WF** - Wide flood 58°

**VOLTAGE**

**REM** - Remote

**FINISH\*** (Trim finish / Baffle finish)

	<b>White Trim</b>	<b>Black Trim</b>	<b>Trimless</b>
<input checked="" type="checkbox"/> <b>Black baffle</b>	<input type="checkbox"/> <b>01</b> - White/Black	<input type="checkbox"/> <b>02</b> - Black/Black	<input type="checkbox"/> <b>02</b> - Black
<input checked="" type="checkbox"/> <b>White baffle</b>	<input type="checkbox"/> <b>31</b> - White/White		<input type="checkbox"/> <b>31</b> - White

<sup>(1)</sup>Available for six (06), twelve (12) and eighteen (18) models.

**ACCESSORIES**  
(TO BE ORDERED SEPARATELY)

**IPA89-02** - Black central cover for Blade R 06



**IPA90-02** - Black central cover for Blade R 12



**IPA91-02** - Black central cover for Blade R 18 and 30



**REMOTE LED DRIVER OPTIONS**  
(TO BE ORDERED SEPARATELY)

For IBR06-LC • 8.1W\* • 450mA



Min-max units	Watts	Voltage	Dimming protocol	Dimming range	Connexion box dimensions	Max distance**	Connection box
1	10	120V	Leading and trailing edge (ELV and TRIAC)	Down to ±1%	6" x 4" x 3" (152 x 102 x 76mm)	30ft (9m)	<b>4444-0440-010-120-LTE</b> <input type="checkbox"/>
1-2	17	120-277V	Lutron Hi Lume® 1% EcoSystem™ (Soft-on, Fade to Black)	Down to ±1%	5" x 4" x 3" (127 x 102 x 76mm)	118ft (36m)	<b>4443-0450-017-UNV-D2</b> <input type="checkbox"/>
1-2	24	120-277V	0-10V	Down to ±10%	8" x 8" x 4" (203 x 203 x 101mm)	30ft (9m)	<b>4450-0450-024-UNV-D10</b> <input type="checkbox"/>
1-2	24	120-277V	0-10V ELDOLED ECOdrive	Down to ±1%	8" x 8" x 4" (203 x 203 x 101mm)	30ft (9m)	<b>4450-0450-024-UNV-ED10</b> <input type="checkbox"/>
1-2	24	120-277V	0-10V ELDOLED SOLOdrive	Down to ±0%	8" x 8" x 4" (203 x 203 x 101mm)	30ft (9m)	<b>4450-0450-024-UNV-SD10</b> <input type="checkbox"/>
1-4	49	120-277V	0-10V ELDOLED SOLOdrive	Down to ±0%	8" x 8" x 4" (203 x 203 x 101mm)	30ft (9m)	<b>4450-0450-049-UNV-SD10</b> <input type="checkbox"/>
1-8	100	120-277V	0-10V ELDOLED SOLOdrive	Down to ±0%	10" x 8" x 4" (254 x 203 x 101mm)	30ft (9m)	<b>4448-0450-100-UNV-SD10</b> <input type="checkbox"/>

\* Wattage requirement for one (1) fixture (remote fixture only).

\*\* Calculated for 16AWG cable. Contact customer service for longer remote distance.

**REMOTE LED DRIVER OPTIONS**  
(TO BE ORDERED SEPARATELY)

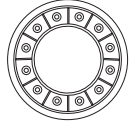

For IBR12-LC • 18W\* • 500mA

Min-max units	Watts	Voltage	Dimming protocol	Dimming range	Connexion box dimensions	Max distance**	Connection box
1	21	120V	Leading and trailing edge (ELV and TRIAC)	Down to ±10%	8" x 8" x 4" (203 x 203 x 101mm)	30ft (9m)	<b>4450-0500-021-120-LTE</b> <input type="checkbox"/>
1	21	120V	0-10V	Down to ±10%	8" x 8" x 4" (203 x 203 x 101mm)	30ft (9m)	<b>4450-0500-021-UNV-D10</b> <input type="checkbox"/>
1	25	120-277V	Lutron Hi Lume® 1% EcoSystem™ (Soft-on, Fade to Black)	Down to ±1%	5" x 4" x 3" (127 x 102 x 76mm)	118ft (36m)	<b>4443-0500-025-UNV-D2</b> <input type="checkbox"/>
1	27	120-277V	0-10V ELDOLED ECOdrive	Down to ±1%	8" x 8" x 4" (3203 x 203 x 102mm)	30ft (9m)	<b>4450-0500-027-UNV-ED10</b> <input type="checkbox"/>
1	27	120-277V	0-10V ELDOLED SOLOdrive	Down to ±0%	8" x 8" x 4" (3203 x 203 x 102mm)	30ft (9m)	<b>4450-0500-027-UNV-SD10</b> <input type="checkbox"/>
1-2	50	120-277V	0-10V ELDOLED SOLOdrive	Down to ±0%	8" x 8" x 4" (3203 x 203 x 102mm)	30ft (9m)	<b>4450-0500-050-UNV-SD10</b> <input type="checkbox"/>
1-4	100	120-277V	0-10V ELDOLED SOLOdrive	Down to ±0%	10" x 8" x 4" (254 x 203 x 102mm)	30ft (9m)	<b>4448-0500-100-UNV-SD10</b> <input type="checkbox"/>

\* Wattage requirement for one (1) fixture (remote fixture only).  
\*\* Calculated for 16AWG cable. Contact customer service for longer remote distance.

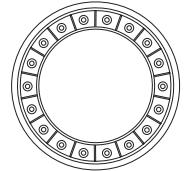

For IBR18-LC • 21.6W\* • 400mA

Min-max units	Watts	Voltage	Dimming protocol	Dimming range	Connexion box dimensions	Max distance**	Connection box
1	21	120-277V	Lutron Hi Lume® 1% EcoSystem™ (Soft-on, Fade to Black)	Down to ±1%	6" x 4" x 3" (152 x 102 x 76mm)	30ft (9m)	<b>4444-0400-021-UNV-D2</b> <input type="checkbox"/>
1	22	120-277V	0-10V	Down to ±10%	8" x 8" x 4" (254 x 203 x 102mm)	30ft (9m)	<b>4450-0400-022-UNV-D10</b> <input type="checkbox"/>
1	22	120-277V	0-10V ELDOLED ECOdrive	Down to ±1%	8" x 8" x 4" (254 x 203 x 102mm)	30ft (9m)	<b>4450-0400-022-UNV-ED10</b> <input type="checkbox"/>
1	22	120-277V	0-10V ELDOLED SOLOdrive	Down to ±0%	8" x 8" x 4" (254 x 203 x 102mm)	30ft (9m)	<b>4450-0400-022-UNV-SD10</b> <input type="checkbox"/>
1-2	44	120-277V	0-10V ELDOLED SOLOdrive	Down to ±0%	8" x 8" x 4" (254 x 203 x 102mm)	30ft (9m)	<b>4450-0400-044-UNV-SD10</b> <input type="checkbox"/>
1-4	91	120-277V	0-10V ELDOLED SOLOdrive	Down to ±0%	10" x 8" x 4" (254 x 203 x 102mm)	30ft (9m)	<b>4448-0400-091-UNV-SD10</b> <input type="checkbox"/>

\* Wattage requirement for one (1) fixture (remote fixture only).  
\*\* Calculated for 16AWG cable. Contact customer service for longer remote distance.

**REMOTE LED DRIVER OPTIONS**  
(TO BE ORDERED SEPARATELY)

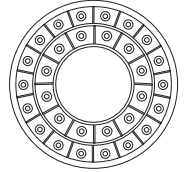

For IBR30-LC • 22.5W\* • 250mA

Min-max units	Watts	Voltage	Dimming protocol	Dimming range	Connexion box dimensions	Max distance**	Connection box
1	27	120-277V	Lutron Hi Lume® 1% EcoSystem™ (Soft-on, Fade to Black)	Down to ±1%	8" x 8" x 4" (203 x 203 x 101mm)	30ft (9m)	<b>4455-0250-027-UNV-D2***</b> <input type="checkbox"/>
1	27	120-277V	0-10V	Down to ±10%	8" x 8" x 4" (203 x 203 x 101mm)	30ft (9m)	<b>4455-0250-027-UNV-D10***</b> <input type="checkbox"/>
1	27	120-277V	0-10V ELDOLED SOLOdrive	Down to ±1%	8" x 8" x 4" (203 x 203 x 101mm)	30ft (9m)	<b>4455-0250-027-UNV-ED10***</b> <input type="checkbox"/>
1	27	120-277V	0-10V ELDOLED SOLOdrive	Down to ±0%	8" x 8" x 4" (203 x 203 x 101mm)	30ft (9m)	<b>4450-0250-027-UNV-SD10</b> <input type="checkbox"/>
2	57	120-277V	0-10V ELDOLED SOLOdrive	Down to ±0%	8" x 8" x 4" (203 x 203 x 101mm)	30ft (9m)	<b>4448-0250-057-UNV-SD10</b> <input type="checkbox"/>

\* Wattage requirement for one (1) fixture (remote fixture only).  
\*\* Calculated for 16AWG cable. Contact customer service for longer remote distance.

**WIRING DIAGRAMS**

\*Multiple luminaires must be connected in series (home run or fixture chain)

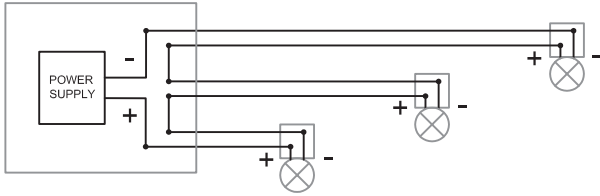

\*\*\* The ibr30 luminaires are controlled by two drivers.

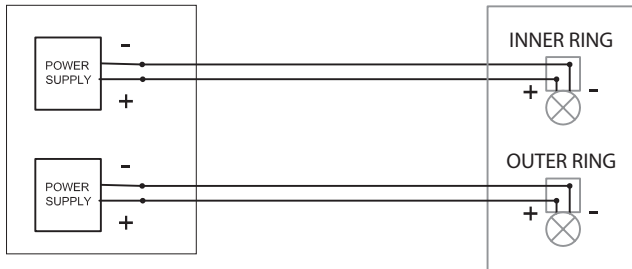

**INSTALLATION**

**Remodel (RF)**

Versatile fixture for new or existing ceiling structure. Suitable for insulated or non-insulated ceiling assemblies, like sheetrock, or paneling. Fixture is ready for remodeling installation. Trimless frame kit and fixture can be shipped separately. Installation from below. **(Power supply is not accessible from luminaire opening)**



**Ceiling thickness:**

Trim: 3/8" to 1 1/8" (3mm - 29mm)  
Trimless: 5/8" (16mm)

Model	Mounting	Trimless frame kit	Cut-out dimension	Clearance (H)
IBR06	Trim		Ø 3 1/4" (Ø 83mm)	2" (51mm)
	Trimless	TK-BR06TL-RF	Ø 3 3/8" (Ø 86mm)	
IBR12	Trim		Ø 5" (Ø 127mm)	
	Trimless	TK-BR12TL-RF	Ø 5 1/8" (Ø 130mm)	
IBR18	Trim		Ø 6 3/4" (Ø 172mm)	3" (76mm)
	Trimless	TK-BR18TL-RF	Ø 6 7/8" (Ø 175mm)	
IBR30	Trim		Ø 6 3/4" (Ø 172mm)	

**New construction with plaster frame (NC)**

Plaster frame with hanger bars system to be installed during rough-in phase. Suitable for insulated or non-insulated new construction ceiling assemblies, like sheetrock, acoustic tiles, or paneling. Plaster frame and fixture can be shipped separately. **(Power supply is not accessible from luminaire opening)**

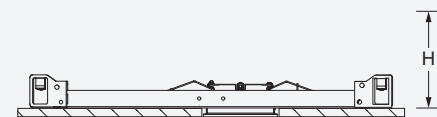

**Ceiling thickness:**

Trim: 3/8" to 1 1/8" (3mm - 29mm)  
Trimless: 5/8" (16mm)

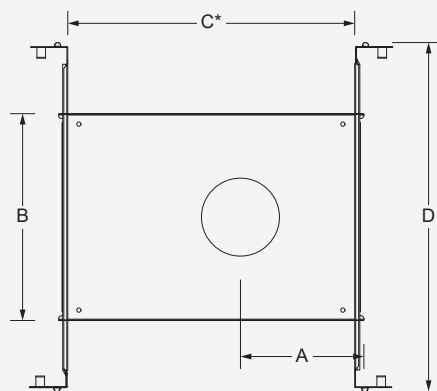

\*Provide a minimum of 1 7/8" (46mm) on each side for the hanger bar fixations

Model	Mounting	Plaster Frame	Cut-out dimensions	Cut-out position (A)	Overall dimensions (BxC)	Hanger bars (D)	Clearance (H)
IBR06	Trim	BN-BR06TR-NC	Ø 3 1/4" (Ø 83mm)	5" (127mm)	8 5/8" x 12" (219mm x 304mm)	9" to 15 1/4" (229 to 387mm)	2" (51mm)
	Trimless	BN-BR06TL-NC	Ø 3 3/8" (Ø 86mm)				
IBR12	Trim	BN-BR12TR-NC	Ø 5" (Ø 127mm)	6 1/2" (165mm)			
	Trimless	BN-BR12TL-NC	Ø 5 1/8" (Ø 130mm)				
IBR18	Trim	BN-BR18TR-NC	Ø 6 3/4" (Ø 172mm)	3 3/8" (86mm)	9" x 18" (229mm x 458mm)	3" (76mm)	
	Trimless	BN-BR18TL-NC	Ø 6 7/8" (Ø 175mm)				
IBR30	Trim	BN-BR30TR-NC	Ø 6 3/4" (Ø 172mm)				

**TRIM MODELS DIMENSIONS**

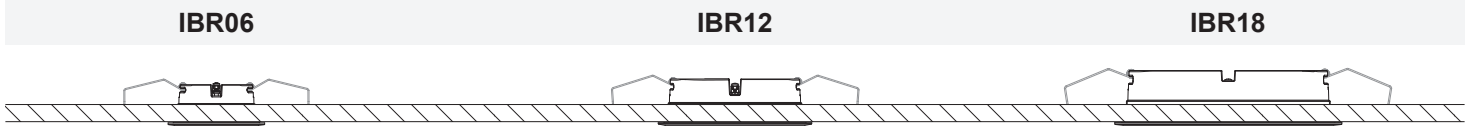

**IBR06**

**IBR12**

**IBR18**

**SIDE VIEW**

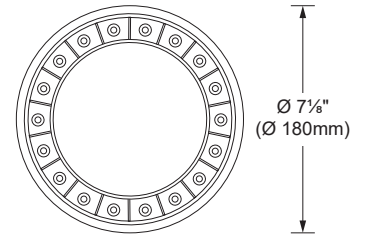
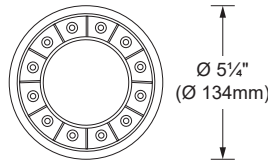
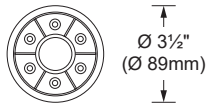

**BOTTOM VIEW**

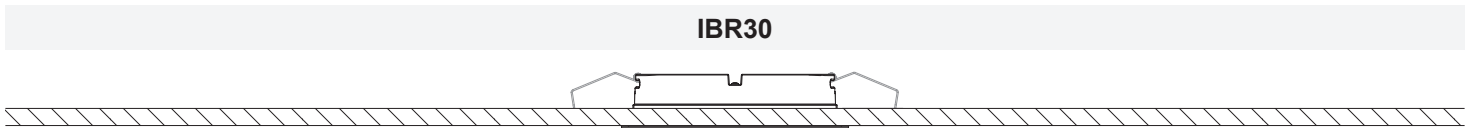

**IBR30**

**SIDE VIEW**

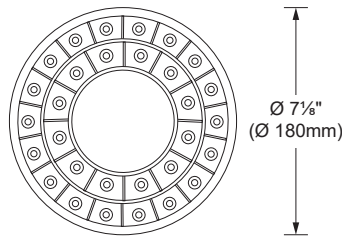

**BOTTOM VIEW**

**TRIMLESS MODELS DIMENSIONS**

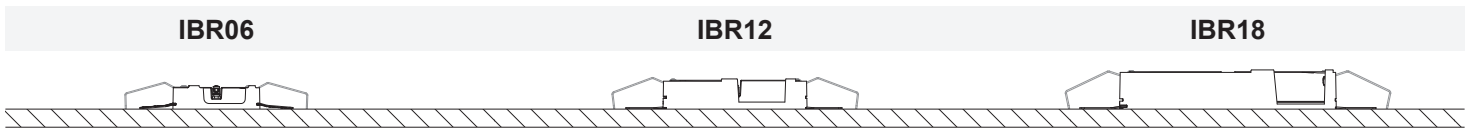

**IBR06**

**IBR12**

**IBR18**

**SIDE VIEW**

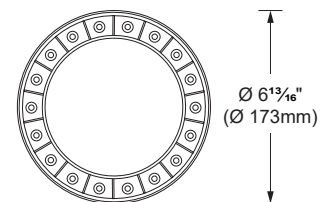
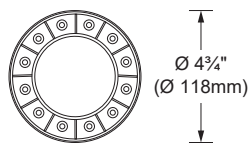
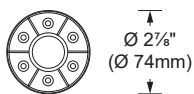

**BOTTOM VIEW**

**LED COLOR FIDELITY DATA**

CRI	CCT	R1	R2	R3	R4	R5	R6	R7	R8	R9	R10	R11	R12	R13	R14	R15	Rf	Rg	Melanopic ratio
80	4000K	81	92	96	79	81	87	85	64	13	79	77	64	84	98	76	82	93	0.707
90	2700K	94	94	91	93	93	92	93	88	70	84	94	82	94	94	92	88	104	0.456
	3000K	97	96	93	94	96	94	95	92	82	89	94	86	97	95	96	90	104	0.538
	3500K	99	99	98	98	98	97	97	96	93	99	99	83	99	98	98	92	99	0.666
	4000K	94	94	93	94	92	91	97	91	74	85	91	72	93	96	92	91	99	0.744

**PHOTOMETRIC DATA**

Photometric performance is measured in accordance with IESNA LM-79. Visit iguzzini.com for complete photometric data.

**IBR06**



CCT (K)*	CRI	LOAD (W)	OPTIC	LUMENS (lm)	EFFICACY (lm / w)	MAX CANDELA (cd)	MODELS
3000K	90	7.5W	Medium 24°	575	76	2 750	IBR06-LC-930-MD
			Flood 40°	595	79	1 360	IBR06-LC-930-FL
			Wide flood 58°	600	80	780	IBR06-LC-930-WF

\*USE MULTIPLIER TABLE BELOW FOR OTHER CCT AND CRI OUTPUT DATA

Medium 24° (3000K, 90CRI)

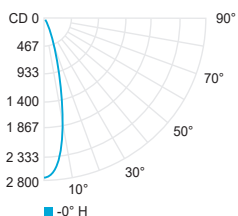

Flood 40° (3000K, 90CRI)

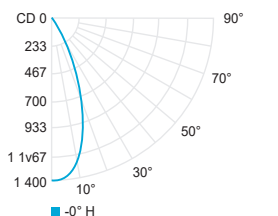

Wide flood 58° (3000K, 90CRI)

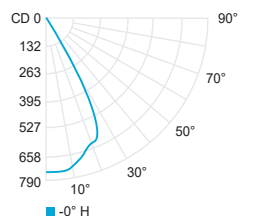

CCT options	2700K	3000K	3500K	4000K*	4000K
CRI options	90CRI	90CRI	90CRI	90CRI*	80CRI
<b>Multiplier</b>	<b>0.94</b>	<b>1.00</b>	<b>1.05</b>	<b>1.11*</b>	<b>1.33</b>

\*Available for IBR06, IBR12 and IBR18 model



**PHOTOMETRIC DATA**

Photometric performance is measured in accordance with IESNA LM-79.  
Visit [iguzzini.com](http://iguzzini.com) for complete photometric data.

**IBR12**



CCT (K)*	CRI	LOAD (W)	OPTIC	LUMENS (lm)	EFFICACY (lm / w)	MAX CANDELA (cd)	MODELS
3000K	90	17W	Medium 24°	1 220	71	5 520	IBR12-LC-930-MD
			Flood 40°	1 300	76	2 765	IBR12-LC-930-FL
			Wide flood 58°	1 315	77	1 870	IBR12-LC-930-WF

\*USE MULTIPLIER TABLE BELOW FOR OTHER CCT AND CRI OUTPUT DATA

Medium 24° (3000K, 90CRI)

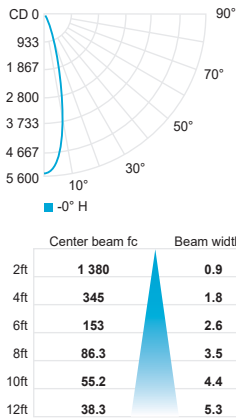

Flood 40° (3000K, 90CRI)

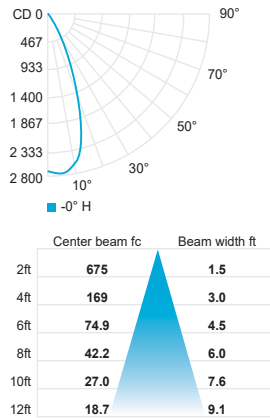

Wide flood 58° (3000K, 90CRI)

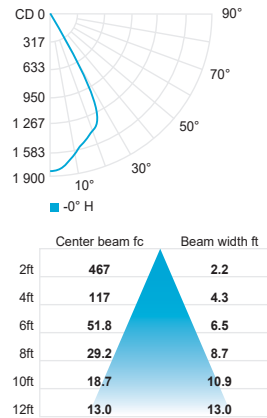

**IBR18**

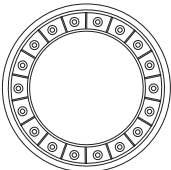

CCT (K)*	CRI	LOAD (W)	OPTIC	LUMENS (lm)	EFFICACY (lm / w)	MAX CANDELA (cd)	MODELS
3000K	90	20W	Medium 24°	1 535	76	6 785	IBR18-LC-930-MD
			Flood 40°	1 615	80	3 205	IBR18-LC-930-FL
			Wide flood 58°	1 635	81	2 050	IBR18-LC-930-WF

\*USE MULTIPLIER TABLE BELOW FOR OTHER CCT AND CRI OUTPUT DATA

Medium 24° (3000K, 90CRI)

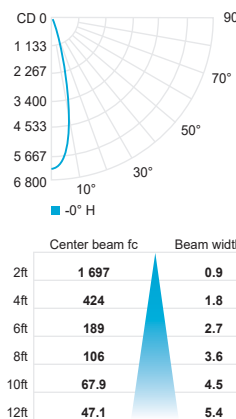

Flood 40° (3000K, 90CRI)

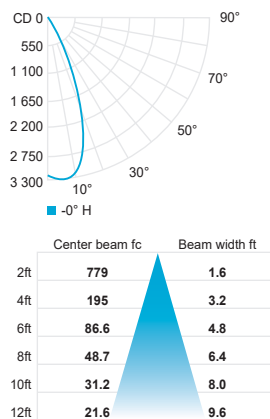

Wide flood 58° (3000K, 90CRI)

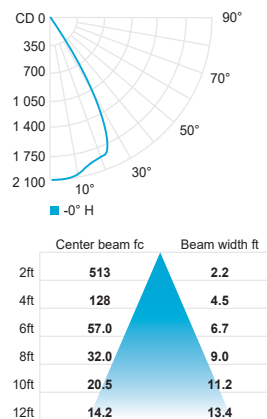

CCT options	2700K	3000K	3500K	4000K*	4000K
CRI options	90CRI	90CRI	90CRI	90CRI*	80CRI
<b>Multiplier</b>	<b>0.94</b>	<b>1.00</b>	<b>1.05</b>	<b>1.11*</b>	<b>1.33</b>

\*Available for IBR06, IBR12 and IBR18 model

**PHOTOMETRIC DATA**

Photometric performance is measured in accordance with IESNA LM-79.  
Visit [iguzzini.com](http://iguzzini.com) for complete photometric data.

**IBR30**

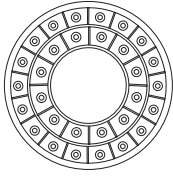

CCT (K)*	CRI	LOAD (W)	OPTIC	LUMENS (lm)	EFFICACY (lm / w)	MAX CANDELA (cd)	MODELS
3000K	90	21W	Medium 24°	1 655	78	7 780	IBR30-LC-930-MD
			Flood 40°	1 740	82	3 660	IBR30-LC-930-FL
			Wide flood 58°	1 760	83	2 410	IBR30-LC-930-WF

\*USE MULTIPLIER TABLE BELOW FOR OTHER CCT AND CRI OUTPUT DATA

Medium 24° (3000K, 90CRI)

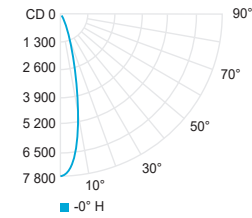

Center beam fc	Beam width ft
3.3ft	1 946
6.7ft	486
10ft	216
13.3ft	122
16.7ft	77.8
20ft	54.0

Flood 40° (3000K, 90CRI)

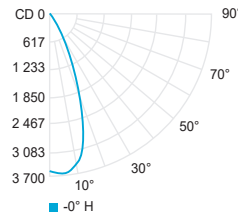

Center beam fc	Beam width ft
3.3ft	900
6.7ft	225
10ft	99.9
13.3ft	56.2
16.7ft	36.0
20ft	25.0

Wide flood 58° (3000K, 90CRI)

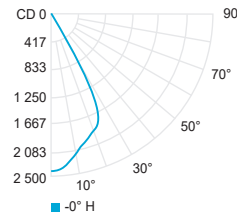

Center beam fc	Beam width ft
3.3ft	603
6.7ft	151
10ft	67.0
13.3ft	37.7
16.7ft	24.1
20ft	16.8

CCT options	2700K	3000K	3500K	4000K*	4000K
CRI options	90CRI	90CRI	90CRI	90CRI*	80CRI
<b>Multiplier</b>	<b>0.94</b>	<b>1.00</b>	<b>1.05</b>	<b>1.11*</b>	<b>1.33</b>

\*Available for IBR06, IBR12 and IBR18 model