

Luminaire characteristic:

TOTAL POWER / ft	OPTIC	LUMEN (lm/ft)*	EFFICACY (lm/w)*	MAX CANDELA (cd)*
3.9W/ft	SP 10°x10°	384	98	2273
	FL 34°x34°	384	98	1231
	WF 56°x56°	413	105	556
	GL 45°x82°	183	47	183
	WGS 14°x14°	304	78	1158
	WGM 23°x41°	295	76	578
	WGMF 27°x60°	271	69	423
	WGS-ML 14°x14°	204	52	790
	WGM-ML 23°x41°	195	50	407
	WGMF-ML 26°x59°	180	46	305
	WG 21°x80°	141	36	170
ELL 22°x60°	342	88	650	

For 3000K, 80 CRI

Source:

White LED (LM-80 tested),
2200K: 80CRI,
2700K: 80CRI,
3000K: 80CRI,
3500K: 80CRI,
4000K: 80CRI.

Lumen maintenance:

85% of initial lumens at 100 000 hours (L85 B10)
Ta 77°F and 104°F (25° and 40°)

Optic:

Symmetrical optics: Spot, flood, wide flood or general light.
Wall grazer optics: Spot, medium, wide flood or no-dot. Wall grazer spot, medium and wide flood are also offered with internal micro-louver.
Elliptical optic: 22°x60°

Material:

Body: Extruded aluminum.
End caps: Die-cast aluminum with silicone seals.
Protective screen: 1/4" (5mm) transparent glass.
Hardware: Stainless steel.

Mounting:

Ceiling, floor or wall mounted with fix-flat or arm accessories. Ground installation with arms on spike.

Electrical:

24Vdc remote LED driver. See remote option page 4.

Dimming:

1-10V dimming (120-277V) down to 10% (on full load), DMX RDM (120-277V) or DALI (120-277) down to 0.1%. See dimming options page 4.

Temperature of operation:

-22°F to 122°F (-30°C to 50°C)

Glass surface temperature:

104°F (40°C) maximum.

Finish:

Black, gray (RAL9007), rust brown or white (RAL9016), with a high level of weather and UV resistance. The semi-gloss finish coating is electrostatically applied, durable acrylic enamel baked at high temperatures for superior color retentive finish.

Weight:

0.99lb/ft (0.45kg/ft)

Warranty:

5 year limited warranty.

Ratings:

IP66, IK06

Certification:



cULus for wet location.

ORDERING INFO



PRODUCT CODE

MODEL	LENGTH ¹	OUTPUT	LED	OPTIC	MOUNTING	ARM	REM	FINISH	EXTERNAL OPTIONAL ACCESSORIES ⁵												
ILL27S Linealuce 27 Surface	01 1.08' (329mm)	BO Base output	822 2200K, 80CRI	SYMMETRICAL⁶	S³ Surface Flat installation no arm	1³ No arm	REM Remote	01 White	A1 Satin screen												
	02 2.05' (625mm)		827 2700K, 80CRI	SP² Spot 10°x10°																	
	03 3.02' (920mm)		830 3000K, 80CRI	FL Flood 34°x34°						M Arm installation for height below 9.5' (3m)	2 Black short adjustable 1-5/8" (41mm)	02 Black	15 Gray	A2 Visor	A3 Transversal louver						
	04 3.99' (1216mm)		835 3500K, 80CRI	WF Wide flood 56°x56°						U Arm installation for height greater than 9.5' (3m)	3 Steel short adjustable 1-5/8" (41mm)					F5 Rust brown	A4 Longitudinal louver	A5 Honeycomb louver			
	05 4.96' (1511mm)		840 4000K, 80CRI	GL General light, No-dot 45°x82°						G Ground Spike in soil with arm	4 Black adjustable arms 2-3/4" (71mm)								A6 Visor + transversal louver	A7 Linear prismatic screen	A8 Protective frame (For IK10)
	06 6.04' (1842mm)		GRAZER	WGS Spot 14°x14°							5 Steel adjustable arms 2-3/4" (71mm)										
	07 7.01' (2138mm)		WGM Medium 23°x41°	WGWF Wide flood 27°x60°							6 Black adjustable arms 4-3/4" (121mm)										
	08 7.99' (2434mm)		WG No-dot 21°x80°	WGS-ML Spot 14°x14°							7 Steel adjustable arms 4-3/4" (121mm)										
	09 8.95' (2729mm)		WGM-ML Medium 23°x41°	WGWF-ML Wide flood 26°x59°							8 Black adjustable arms 8-3/4" (221mm)										
	10 9.92' (3024mm)		ELLIPITICAL	ELL² Elliptical 22°x60°							9 Steel adjustable arms 8-3/4" (221mm)										
	11 11.01' (3355mm)		GRAZER WITH INTERNAL MICROLOUVER								10⁴ Black single adjustable arm 4-3/4" (121mm) for 1ft module only										
	12 11.98' (3651mm)										11⁴ Stainless steel single adjustable arm 4-3/4" (121mm) for 1ft module only										
	13 12.95' (3946mm)																				
	14 13.91' (4242mm)																				
	15 14.89' (4537mm)																				
	16 15.98' (4868mm)																				
	17 16.94' (5164mm)																				
	18 17.91' (5459mm)																				
	19 18.88' (5755mm)																				
	20 19.84' (6050mm)																				

(1) Length 6ft and more are module composition in continuous row.
(2) Elliptic and spot optics are available in 1ft, 2ft and 3ft module.
(3) For Surface flat without arm mounting only (S1)

(4) Available for mounting G, 1ft module only
(5) Consult Instruction sheet to see optic/accessory recommendations
(6) Optics not recommended for wall lighting

INCLUDED IN PRODUCT CODE

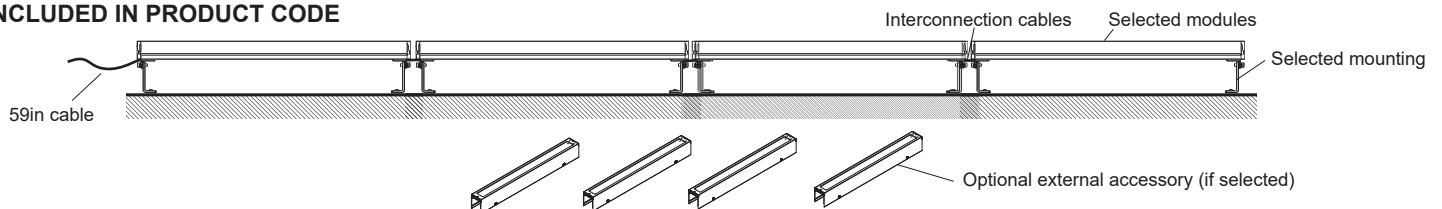

ACCESSORIES

(TO BE ORDERED SEPARATELY)

All optical accessories are external. Consult instruction sheet for limitations and detail on installation.
 All optical accessories must be assembled to the product before installation.

A1- Satin screen

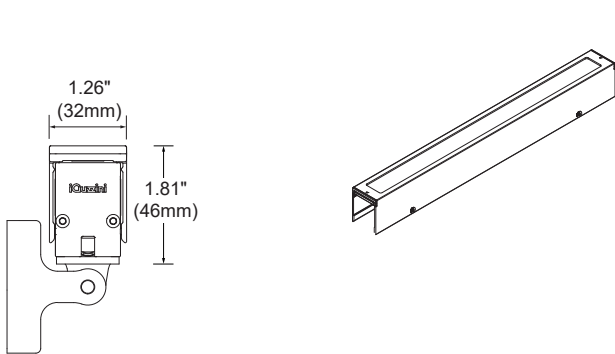

A2- Visor

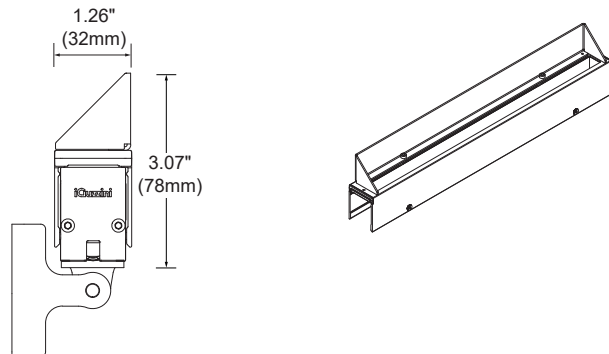

A3- Transversal louver

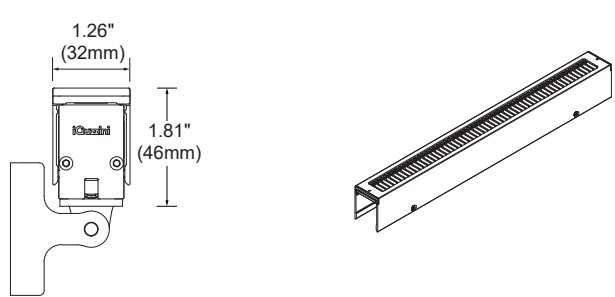

A4- Longitudinal louver

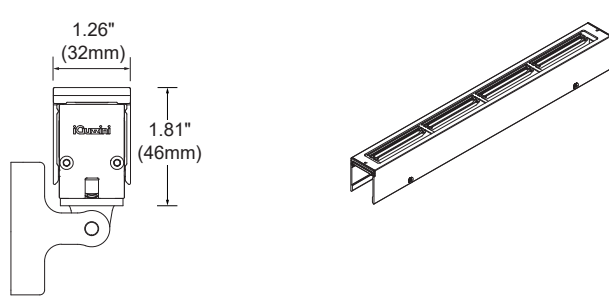

A5- Honeycomb louver

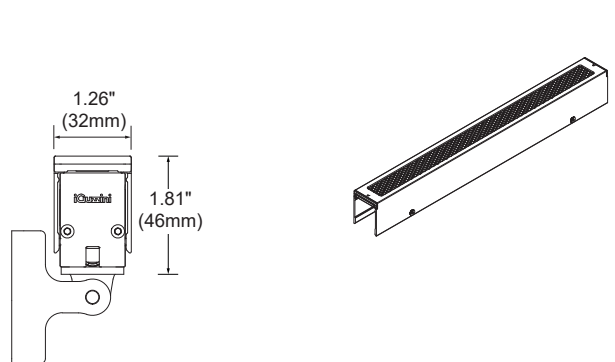

A6- Visor + transversal louver

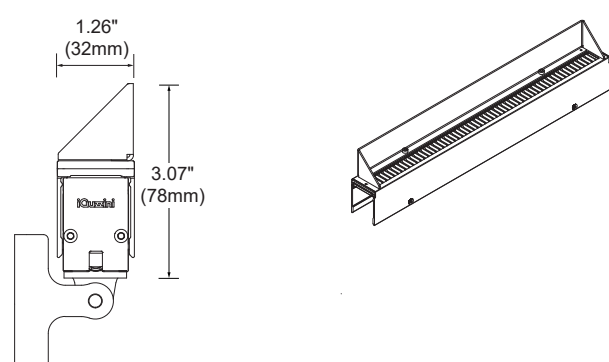

A7- Linear prismatic screen

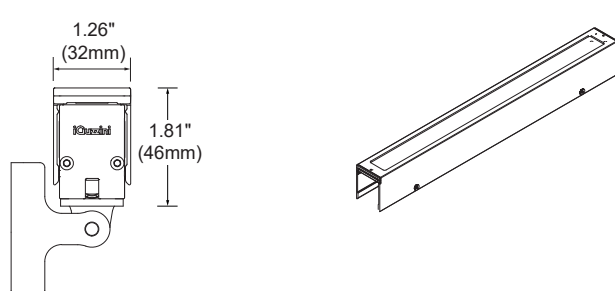

A8- Protective frame (For IK10)

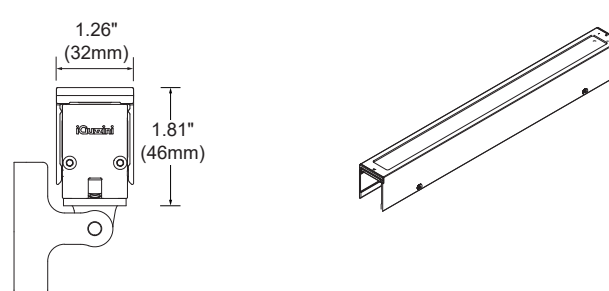

REMOTE LED DRIVER OPTIONS (TO BE ORDERED SEPARATELY)

PRODUCT CODE

INDOOR RATED DRIVERS

Driver box model	Min-max
	ILL27S 3.9W/ft
4449-0024A-060-UNV-ND 4449-0024A-060-UNV-D10 4449-0024A-060-UNV-DA 4449-0024A-060-UNV-LDMX	up to 15ft Linealuce module per feed
4449-0024A-100-UNV-ND 4449-0024A-100-UNV-D10 4449-0024A-100-UNV-DA 4449-0024A-100-UNV-LDMX	25ft (20ft of Linealuce module per feed)

OUTDOOR RATED DRIVERS

Driver box model	Min-max
	ILL27S 3.9W/ft
4549-0024A-060-UNV-ND 4549-0024A-060-UNV-D10 4555-0024A-060-UNV-DA 4555-0024A-060-UNV-LDMX	up to 15ft Linealuce module per feed
4549-0024A-100-UNV-ND 4549-0024A-100-UNV-D10 4555-0024A-100-UNV-DA 4555-0024A-100-UNV-LDMX	25ft (20ft of Linealuce module per feed)

DRIVER BOX MODEL DESCRIPTION

DIMENSION	CONSTANT VOLTAGE	WATTAGE	VOLTAGE	DIMMING PROTOCOL	
4449 12" x 8" x 4" (305 x 203 x 101mm) 4549 14.5" x 5" x 3.5" (368 x 127 x 89mm) 4555 13" x 9" x 4.5" (330 x 228 x 114mm)	0024A 24 Vdc adjustable from 22 to 27Vdc via a built in potentiometer	060 to 100 60W to 100W	UNV 120-277V	ND On/off D10 1-10V Max distance: 16ft (5m)* (down to 10% on full load) DA DALI (module capacity 720W) Max distance: 16ft (5m)* (down to 0.1%) LDMX DMX (module capacity 720W) Max distance: 16ft (5m)* (down to 0.1%)	*Calculated for 20 AWG cable on a 20ft line with Vstart 25V. With bigger gauge from remote driver to relay wet location junction box, you can achieve longer distance. Consult installation sheet or contact factory for longer remote distance.

ACCESSORIES

(TO BE ORDERED SEPARATELY)

Consult instruction sheet for detail on installation.

- IX720-** 2ft (600mm) ø0.15in cable with male/female connector. 20AWG, black.



- IX170-** 10ft (3000mm) ø0.15in cable with female connector. 20AWG, black.



- IX721-** 5ft (1500mm) ø0.15in cable with male/female connector. 20AWG, black.



- IX171-** 16ft (5000mm) ø0.15in cable with female connector. 20AWG, black.



- IX773-** 1ft (350mm) ø0.15in cable with female connector. 20AWG, black.



- IX173-** 5ft (1500mm) ø0.15in cable with male connector. 20AWG, black.



- IX169-** 5ft (1500mm) ø0.15in cable with female connector. 20AWG, black.



- 4543-00-** Wet location junction box. Aluminium unfinished. Includes 3 cable clamp for ø3/16 to 7/16in cable and 1 plug.

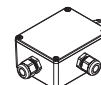

SUGGESTED WIRING DIAGRAM

Consult instruction sheet for wiring details and calculation.

LED DRIVER CODE : 4XXX-0024A-060-UNV-D10

Wmax for in line with 3.9W/ft: 58.5W - 15ft (4.5m)

Wmax for driver box: 60W

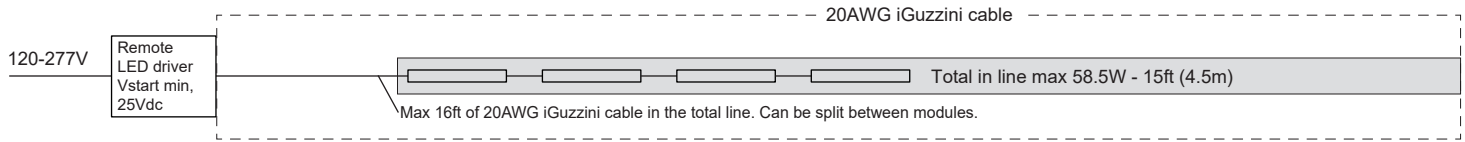

LED DRIVER CODE : 4XXX-0024A-100-UNV-D10

Wmax for in line with 3.9W/ft: 78W - 20ft (6m)

Wmax for driver box: 100W

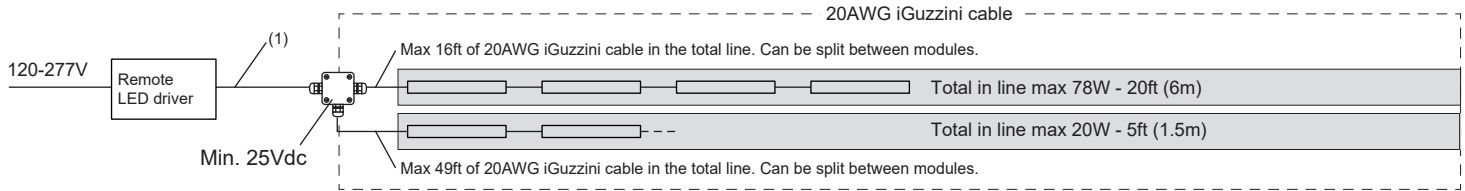

(1) Cable by other. Cable type : Outdoor rated Ø3/16" to 7/16" 2/20AWG minimum. Use drop voltage calculator in instruction sheet.

DIMENSIONS

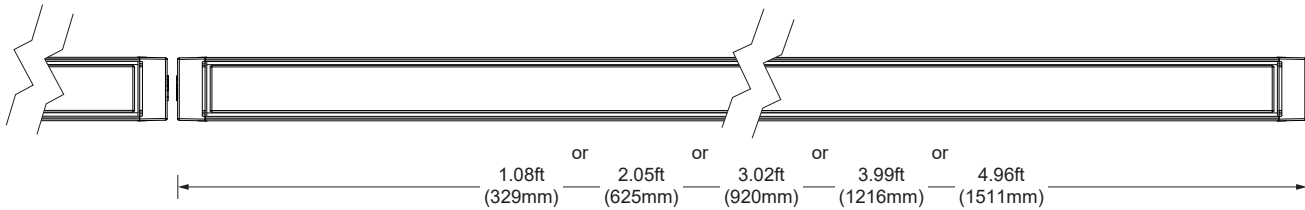

TOP VIEW

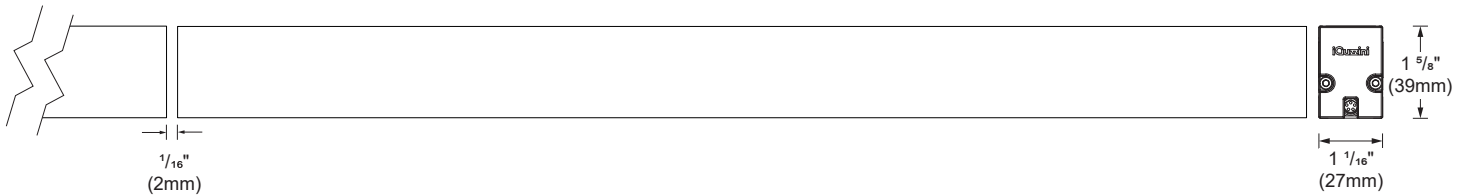

SIDE VIEW

FRONT VIEW

MOUNTING AND DIMENSIONS

Consult instruction sheet for detail on installation.

S1 - SURFACE FLAT-FIX INSTALLATION

Plate for flat surface mounting (X760).
 For Linealuce 27 1ft module (L=329mm).
 Need a width clearance of 2⁵/₈" (67mm) to install.*

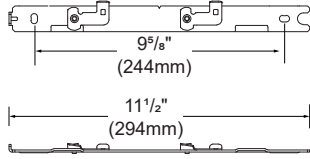

Plate for flat surface mounting (X693).
 For Linealuce 27 2ft and 3ft module (L=628 and 920mm).
 Need a width clearance of 2⁵/₈" (67mm) to install.*

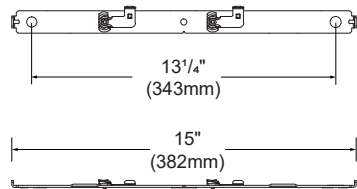
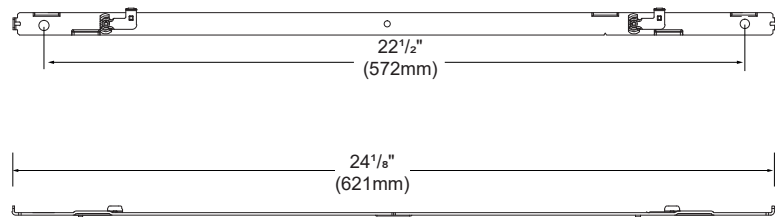
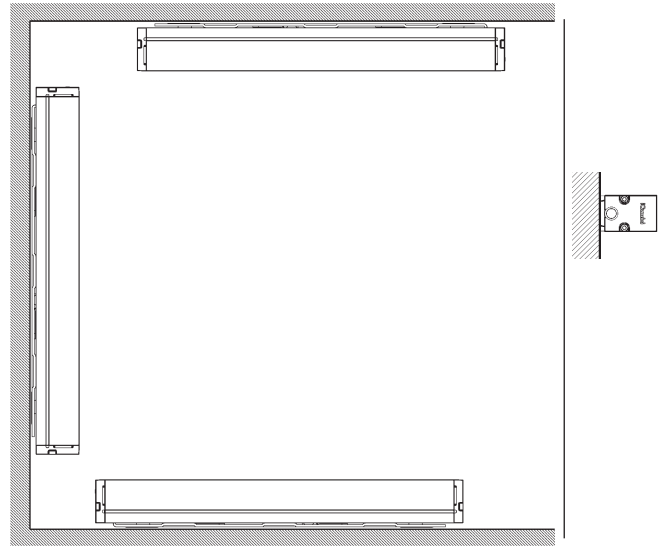

Plate for flat surface mounting (X694).
 For Linealuce 27 4ft and 5ft module (L=1216 and 1511mm).
 Need a width clearance of 2⁵/₈" (67mm) to install.*



PERMITTED INSTALLATION POSITION



*Need minimum width clearance of 2⁵/₈" (67mm) to install.

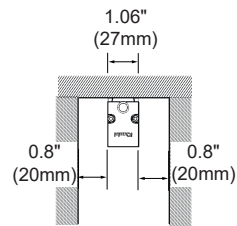

Dimension when tab are opened

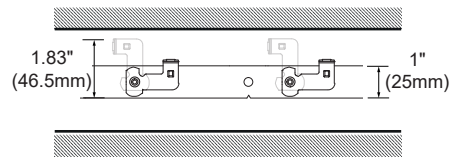

ARM INSTALLATION FOR HEIGHTS LESS THAN 9.5ft (3m)

M2-M3 - Adjustable arms L=1⁵/₈"(41mm)
(X688)

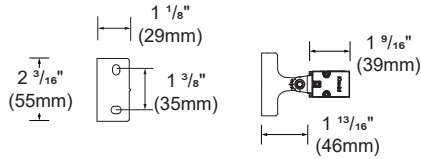

M4-M5 Adjustable arms L=2³/₄"(71mm)
(X689)

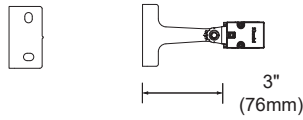

M6-M7 - Adjustable arms L=4³/₄"(121mm)
(X690)

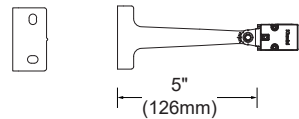

M8-M9 - Adjustable arms L=8³/₈"(221mm)
(X691)

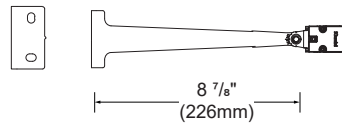

PERMITTED INSTALLATION POSITION

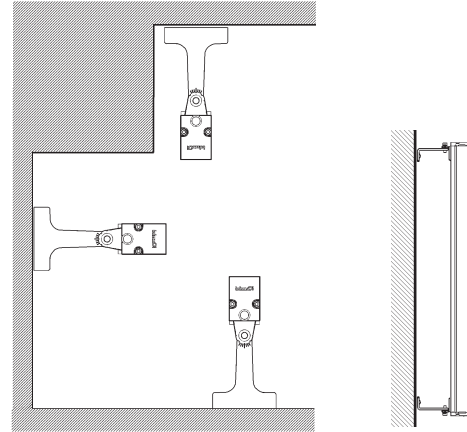

MOUNTING AND DIMENSIONS

Consult instruction sheet for detail on installation.

ARM INSTALLATION FOR HEIGHTS MORE THAN 9.5ft (3m)

U2-U3 - Adjustable arms L=1⁵/₈"(41mm)
(X688)

Weight	EPA
0.44lb (0.20kg)	0.022ft ² (0.002m ²)

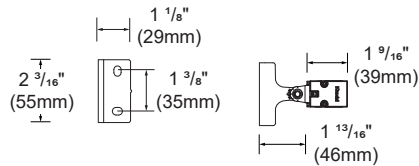

U4-U5 - Adjustable arms L=2³/₄"(71mm)
(X770)

Weight	EPA
0.68lb (0.31kg)	0.022ft ² (0.002m ²)

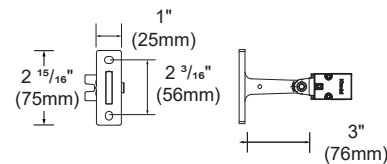

U6-U7 - Adjustable arms L=5"(121mm)
(X771)

Weight	EPA
0.88lb (0.40kg)	0.032ft ² (0.003m ²)

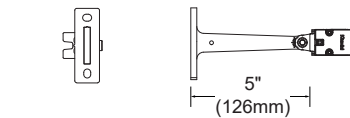

U8-U9 - Adjustable arms L=8³/₈"(221mm)
(X772)

Weight	EPA
1.34lb (0.61kg)	0.075ft ² (0.007m ²)

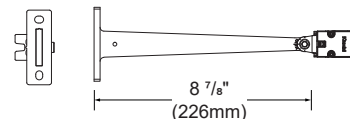

PERMITTED INSTALLATION POSITION

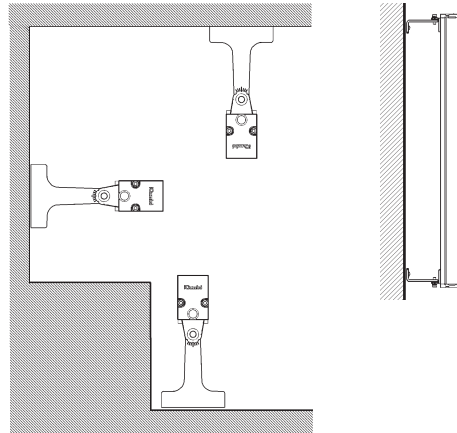

MODELS	EPA*
01 - length 1.08' (329mm)	0.33ft ² (0.031m ²)
02 - length 2.05' (625mm)	0.64ft ² (0.059m ²)
03 - length 3.02' (920mm)	0.95ft ² (0.088m ²)
04 - length 3.99' (1216mm)	1.25ft ² (0.116m ²)
05 - length 4.96' (1511mm)	1.56ft ² (0.145m ²)

* Calculated with visor accessory.

To have the total EPA, add all the value EPA items in composition
Consult page 9 for other length composition

MOUNTING AND DIMENSIONS

Consult instruction sheet for detail on installation.

SPIKE IN SOIL WITH PIVOT ARM

(To be used together with arms)

G2-G3 Spike with adjustable arm 1-5/8"(41mm)

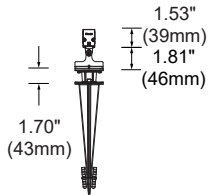

PERMITTED INSTALLATION POSITION

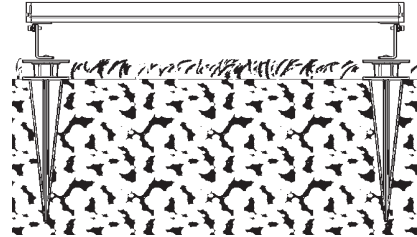

G2 to G9 layout type for 1ft to 5 ft module.

G4-G5 Spike with adjustable arm 2-3/4"(71mm)

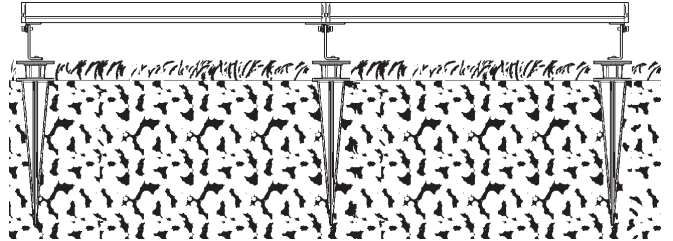
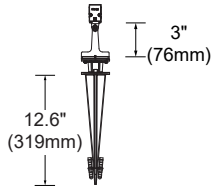

G2 to G9 layout type for 6ft to 20ft length.

G6-G7 Spike with adjustable arm 4-3/4"(121mm)

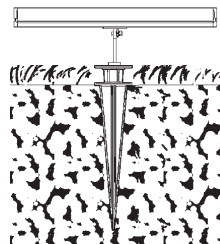
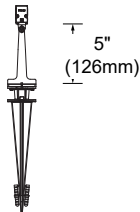

G10-G11 layout for 1ft module

G8-G9 Spike with adjustable arm 8-3/4"(221mm)

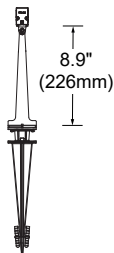



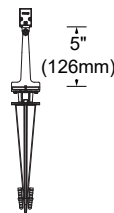

G10-G11 Spike with plate support arm 4-3/4"(121mm)
 (only for Linealuce 27 surface, 1ft (329mm) module)



LENGTHS

Except for 1ft units, all units are equipped with 2 connectors (male/female) for through wiring.
1ft units are equipped with 1 male connector.

Nominal length	Exact length
1	 L: 1.08ft (329mm)
2	 L: 2.05ft (625mm)
3	 L: 3.02ft (920mm)
4	 L: 3.99ft (1216mm)
5	 L: 4.96ft (1511)

CONTINUOUS ROW MODULE

Length 6ft to 20ft are continuous row module compositions. See compositions below.

*Note that 2mm spacing minimum is required for continuous rows installation.

Nominal length	Exact length	Single elements qty
6	6.04ft (1842mm)	2 x 3ft
7	7.01ft (2138mm)	1 x 3ft + 1 x 4ft
8	7.99ft (2434mm)	2 x 4ft
9	8.95ft (2729mm)	1 x 4ft + 1 x 5ft
10	9.92ft (3024mm)	2 x 5ft
11	11.01ft (3355mm)	2 x 5ft + 1 x 1ft
12	11.98ft (3651mm)	2 x 5ft + 1 x 2ft
13	12.95ft (3946mm)	2 x 5ft + 1 x 3ft
14	13.91ft (4242mm)	2 x 5ft + 1 x 4ft
15	14.89ft (4537mm)	3 x 5ft
16	15.98ft (4868mm)	3 x 5ft + 1 x 1ft
17	16.94ft (5164mm)	3 x 5ft + 1 x 2ft
18	17.91ft (5459mm)	3 x 5ft + 1 x 3ft
19	18.88ft (5755mm)	3 x 5ft + 1 x 4ft
20	19.84ft (6050mm)	4 x 5ft

OPTIC OVERVIEW

SYMMETRICAL

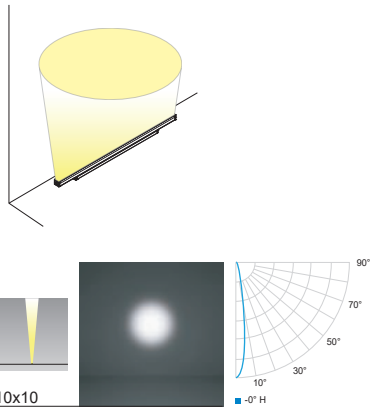

GRAZER

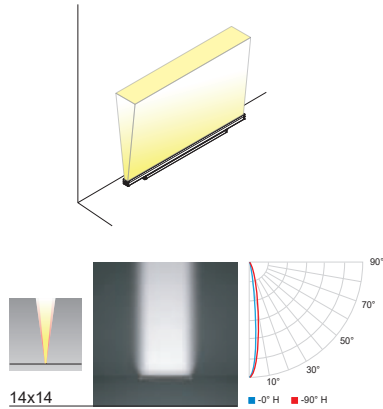

ELLIPTICAL

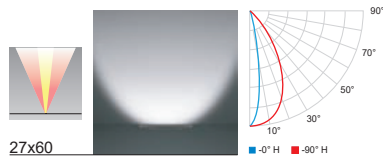
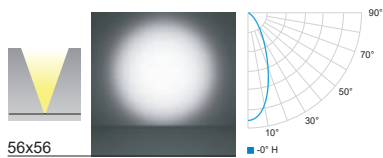
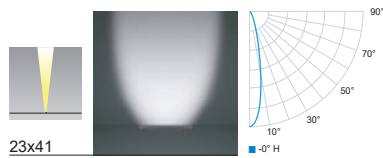
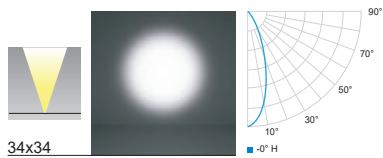
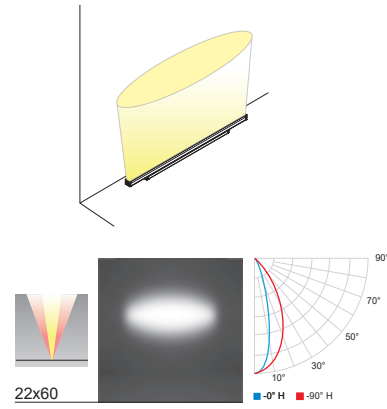

GENERAL LIGHT NO-DOT

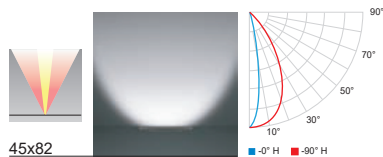

GRAZER NOT-DOT

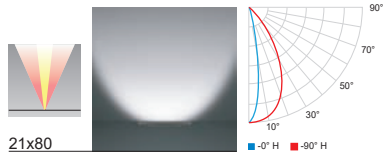

GRAZER + MICROLOUVRE

14x14

23x41

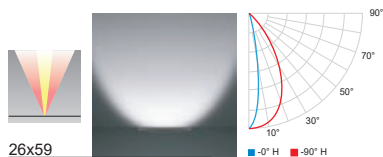

PHOTOMETRIC DATA

Power can vary with selected drivers. Efficacy based on IESNA LM-79 test reports.
Visit iguzzini.com/us/ for complete photometric data.

SPOT 10x10



CCT (K)	CRI	OUTPUT	POWER (W/ft)	LUMENS (lm/ft)	EFFICACY (lm/w)	MAX CANDELA (cd)
3000K	80	BO	3.9W/ft	384	98	2 273

BO Spot (3000K, 80CRI)

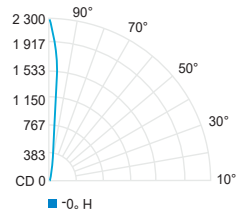

FLOOD 34x34



3000K	80	BO	3.9W/ft	384	98	1 231
-------	----	----	---------	-----	----	-------

BO Flood (3000K, 80CRI)

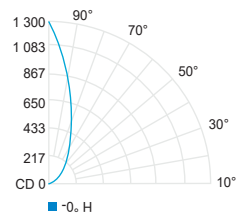

WIDE FLOOD 56x56



3000K	80	BO	3.9W/ft	413	105	556
-------	----	----	---------	-----	-----	-----

BO Wide flood (3000K, 80CRI)

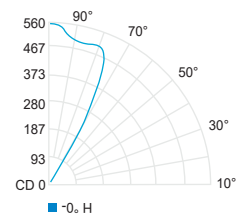

GENERAL LIGHT NO-DOT 45x82



3000K	80	BO	3.9W/ft	183	47	183
-------	----	----	---------	-----	----	-----

BO General light no-dot (3000K, 80CRI)

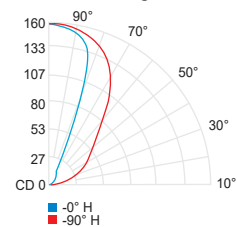

CCT options	2200K	2700K	3000K	3500K	4000K
CRI options	80CRI	80CRI	80CRI	80CRI	80CRI
Multiplier	0.84	0.96	1	1	1.03

PHOTOMETRIC DATA

Power can vary with selected drivers. Efficacy based on IESNA LM-79 test reports.
Visit iguzzini.com/us/ for complete photometric data.

WALL GRAZER SPOT

14x14



CCT (K)	CRI	OUTPUT	POWER (W/ft)	LUMENS (lm/ft)	EFFICACY (lm/w)	MAX CANDELA (cd)
3000K	80	BO	3.9W/ft	304	78	1 158

BO WGS (3000K, 80CRI)

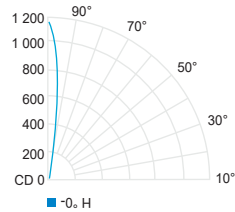

WALL GRAZER MEDIUM

23x41



3000K	80	BO	3.9W/ft	295	76	578
-------	----	----	---------	-----	----	-----

BO WGM (3000K, 80CRI)

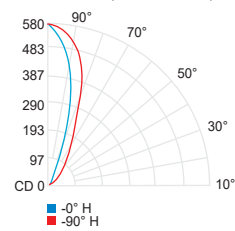

WALL GRAZER WIDE FLOOD

27x60



3000K	80	BO	3.9W/ft	271	69	423
-------	----	----	---------	-----	----	-----

BO WGWF (3000K, 80CRI)

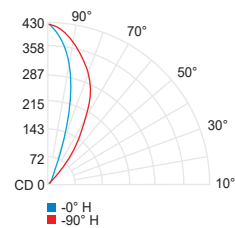

WALL GRAZER SPOT + MICROLOUVER

14x14



3000K	80	BO	3.9W/ft	204	52	790
-------	----	----	---------	-----	----	-----

BO WGS + microlouver (3000K, 80CRI)

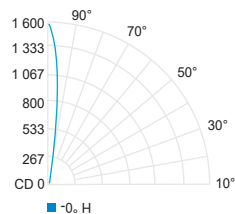

CCT options	2200K	2700K	3000K	3500K	4000K
CRI options	80CRI	80CRI	80CRI	80CRI	80CRI
Multiplier	0.84	0.96	1	1	1.03

PHOTOMETRIC DATA

Power can vary with selected drivers. Efficacy based on IESNA LM-79 test reports.
Visit iguzzini.com/us/ for complete photometric data.

WALL GRAZER MEDIUM + MICROLOUVER

23x41



CCT (K)	CRI	OUTPUT	POWER LOAD (W/ft)	LUMENS (lm/ft)	EFFICACY (lm/w)	MAX CANDELA (cd)
3000K	80	BO	3.9W/ft	195	50	407

BO WGM + microlouver (3000K, 80CRI)

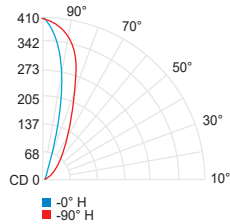

WALL GRAZER WIDE FLOOD + MICROLOUVER

26x59

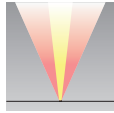

3000K	80	BO	3.9W/ft	180	46	305
-------	----	----	---------	-----	----	-----

BO WGWF + microlouver (3000K, 80CRI)

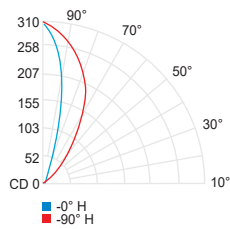

WALL GRAZER NO-DOT

21x80



3000K	80	BO	3.9W/ft	141	36	170
-------	----	----	---------	-----	----	-----

BO WG + no-dot (3000K, 80CRI)

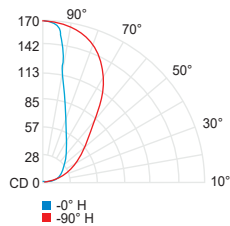

ELLIPTICAL

22x60



3000K	80	BO	3.9W/ft	204	52	790
-------	----	----	---------	-----	----	-----

BO elliptical (3000K, 80CRI)

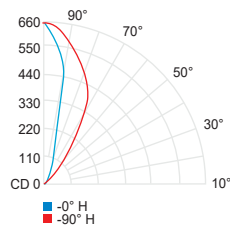

CCT options	2200K	2700K	3000K	3500K	4000K
CRI options	80CRI	80CRI	80CRI	80CRI	80CRI
Multiplier	0.84	0.96	1	1	1.03