

Collection of recessed downlights for architectural applications. Excellent build quality with features for the most demanding professional applications. Available in 2 apertures with complete light distributions offering fixed, adjustable and wall washer optics. Generous light outputs with excellent chromatic performance and enhanced visual comfort (UGR<10). Also available with a Safety glass with a sealing system to increase the IP rating (IP65).

**Luminaire characteristic:** Power input source: 7.5W or 10.5W  
Lumens for 3000K, 90CRI: 591lm to 1 026lm  
Luminaire efficacy for 3000K, 90 CRI: Up to 98lm/W

**Source:** COB LED module (LM-80)  
2700K: 90CRI,  
3000K: 90CRI,  
3500K: 90CRI,  
4000K: 90CRI.

**Lumen maintenance:** 90% of initial lumens at 50 000 hours (L90) (LM-79).

**Optic:** Fixed: Deep recessed reflector available with medium, flood, wide flood or very wide flood optic.  
Adjustable: Deep recessed reflector available with spot, medium, flood or wide flood optic.  
Optical assembly hot aiming adjustment:  
Comfort optic type: 30° tilt.  
Super comfort optic type: 30° tilt and 355°pan.  
Wall washer: Wall washer with lens.  
Visual comfort: UGR < 10

**Material:** Body: Die-cast aluminum optical assembly  
Reflector: Metalized polycarbonate  
Baffle: Painted thermoplastic  
Housing: Galvanized steel

**Mounting:** New construction with housing suitable for insulated ceiling or Chicago Plenum (page 6).

**Electrical:** Integral high efficiency LED driver rated at 50 000 hours, 120V or 277V.

**Finish:** Powder coated body and painted metallized baffle.  
See page 2 for complete offering.

**Weight:** Trim: 0.57lb (0.26kg),  
Trimless: 0.29lb (0.13kg).

**Warranty:** 5 year limited warranty.

**Rating:** IP20, IP44 (under the ceiling for trim fixed)  
IP23 (under the ceiling for trim adjustable)  
IP65 (under the ceiling, see page 2 for availability)

**Certification:** cULus listed for damp location. Interior use only.



**ORDERING INFO**



PRODUCT CODE				INSTALLATION CODE			

SHAPE	MOUNTING	INSTALLATION	LED	OPTIC TYPE	OPTIC	VOLTAGE	FINISH (trim finish / baffle finish)
<b>R</b> Round	<b>T</b> Trim	<b>IC</b> Insulated ceiling housing	<b>927</b> 2700K, 90CRI	<b>SGF</b> <sup>1</sup> Comfort fixed	<b>SP</b> <sup>4</sup> Spot 16°	<b>REM</b> Remote	<b>TRIM</b>
			<b>930</b> 3000K, 90CRI	<b>SGA</b> <sup>1</sup> Comfort adjustable	<b>MD</b> Medium 26°		<b>01</b> White / black
	<b>935</b> 3500K, 90CRI	<b>SCF</b> Super comfort fixed	<b>FL</b> <sup>5</sup> Flood 39°	<b>02</b> Black / black			
	<b>940</b> 4000K, 90CRI	<b>SCA</b> Super comfort adjustable	<b>WF</b> <sup>6</sup> Wide flood 44°	<b>31</b> White / white			
		<b>FWW</b> <sup>2</sup> Fixed wall washer	<b>VW</b> <sup>7</sup> Very wide flood 56°	<b>41</b> * White / gold			
		<b>WGF</b> <sup>1 3</sup> Comfort fixed IP65		<b>E4</b> * White / chrome			
				<b>E7</b> * White / black chrome			
				<b>E9</b> * White / gold matte			
				<b>TRIMLESS</b>			
		<b>L</b> Trimless	<b>CP</b> Chicago Plenum housing				
							<b>02</b> Black
							<b>04</b> * Chrome
							<b>14</b> * Gold
							<b>E6</b> * Black chrome
							<b>E8</b> * Gold matte

<sup>(1)</sup> Available with trim (T) mounting.  
<sup>(2)</sup> No optic selection necessary when ordering the fixed wall washer (FWW) optic type.  
<sup>(3)</sup> Available with 2700K, 90CRI (927) LED.  
<sup>(4)</sup> Available for adjustable (SGA, SCA) optic type.  
<sup>(5)</sup> Available for super comfort adjustable (SCA) optic type.  
<sup>(6)</sup> Available for comfort (SGF, SGA, WGF) optic type. Also available for super comfort fixed (SCF) optic type.  
<sup>(7)</sup> Available for fixed (SGF, SCF) optic type.  
 \* May require a longer lead time than standard. Please contact customer service for details.

## REMOTE LED DRIVER OPTIONS (TO BE ORDERED SEPARATELY)

PRODUCT CODE

### Indoor rated drivers

Driver box model	Min-max units	
	LASER 75 10.5W*	LASER 75 (Only for Super Comfort Adjustable) 7.5W*
4444-0300-012-120-LTE	1	
4444-0300-012-UNV-D10	1	
4444-0300-012-UNV-ED10	1	
4444-0300-012-UNV-SD10	1	
4444-0300-012-UNV-EDA	1	
4444-0300-012-UNV-SDA	1	
4443-0300-015-UNV-D2**	1	
4450-0300-016-UNV-D10	1	
4450-0300-016-UNV-SD10	1	
4448-0300-068-UNV-SD10*** (4 channels)	1-4 1 max.per channel	
4444-0200-008-120-LTE-2		1
4444-0200-008-UNV-D10		1
4444-0200-008-UNV-ED10		1
4444-0200-008-UNV-SD10		1
4444-0200-008-UNV-EDA		1
4444-0200-008-UNV-SDA		1
4450-0200-010-UNV-SD10		1
4450-0200-011-UNV-SD10		1
4448-0200-045-UNV-SD10*** (4 channels)		1-4 1 max.per channel

\* Wattage requirement for one (1) fixture (remote fixture only).

\*\* OEM digital LED driver allotment letter required to order any LUTRON products. Please contact a LUTRON representative for more information.

### DRIVER BOX MODEL DESCRIPTION

DIMENSION	CONSTANT CURRENT	WATTAGE	VOLTAGE	DIMMING PROTOCOL <sup>1</sup>
<b>4443</b> 5" x 4" x 3" (127 x 102 x 76mm)	<b>0200</b> 200mA	<b>008 to 068</b> 8W to 68W	<b>120</b> 120V	<b>D10</b> 0-10V Max distance: 5m (16ft) <sup>2</sup> (down to 10%)
<b>4444</b> 6" x 4" x 3" (152 x 102 x 76mm)	<b>0300</b> 300mA		<b>UNV</b> 120-277V	<b>D2</b> Lutron Hi Lume® 1% EcoSystem™ (Soft-on, Fade to Black) Max distance: 9m (30ft) <sup>2</sup> (down to 1%)
<b>4448</b> 10" x 8" x 4" (254 x 203 x 102mm)				<b>ED10 <sup>3</sup></b> 0-10V eldoLED ECOdrive Max distance: 9m (30ft) <sup>2</sup> (down to 1%)
<b>4450</b> 8" x 8" x 4" (203 x 203 x 102mm)				<b>SD10 <sup>3</sup></b> 0-10V eldoLED SOLOdrive Max distance: 9m (30ft) <sup>2</sup> (down to 0.1%)  Max distance for 4 channels : 36m (118ft) <sup>2</sup> (down to 0.1%)
				<b>LTE</b> Leading edge and trailing edge (ELV and TRIAC) Max distance: 5m (16ft) <sup>2</sup> (down to 10%)
				<b>EDA <sup>3</sup></b> DALI eldoLED ECOdrive Max distance: 9m (30ft) <sup>2</sup> (down to 1%)
				<b>SDA <sup>3</sup></b> DALI eldoLED SOLOdrive Max distance: 9m (30ft) <sup>2</sup> (down to 0.1%)

### WIRING DIAGRAMS



\*\*\*Luminaires must be connected on separate channels (1-4).  
Do not exceed the wattage and voltage range on each channel.

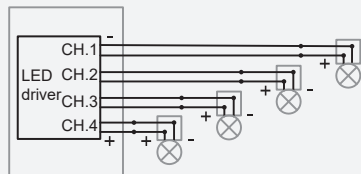

<sup>(1)</sup> Dimming levels will vary depending on the dimmer used and the number of luminaires on the line.

<sup>(2)</sup> Max distance cable calculated for 16AWG cable. Contact customer service for longer remote distance

<sup>(3)</sup> May require a longer lead time than standard. Please contact customer service for details.

**TRIM MODELS DIMENSIONS**

FIXED OPTIC

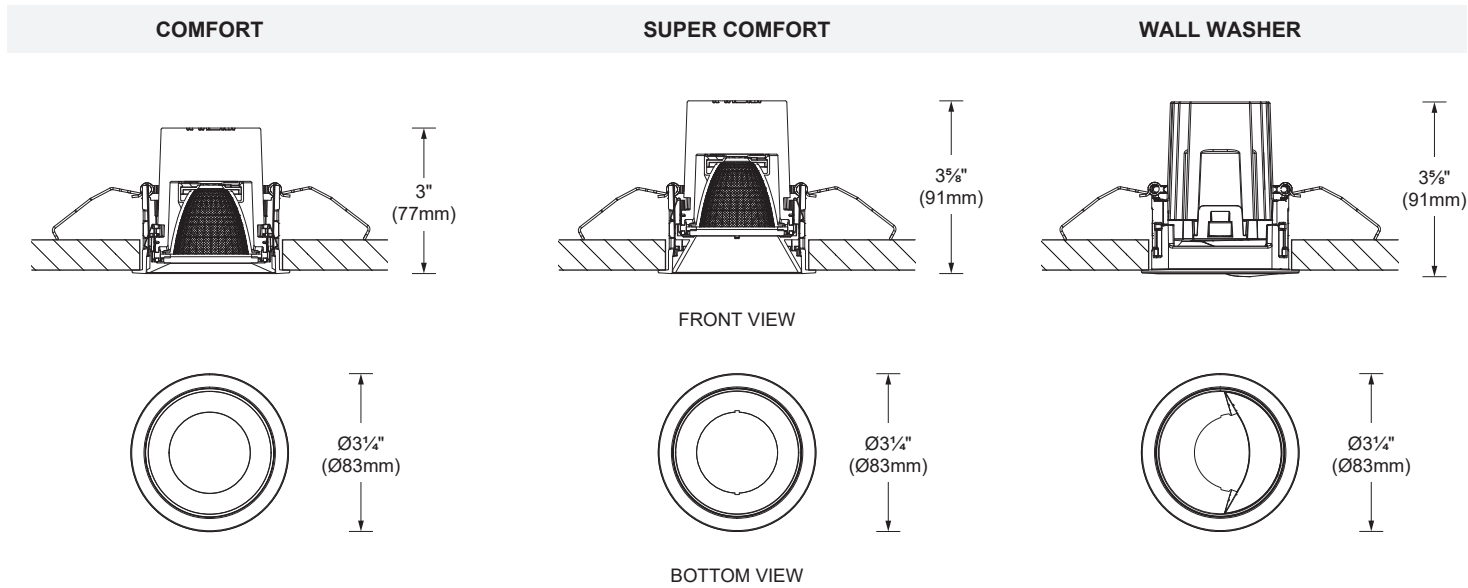

ADJUSTABLE OPTIC

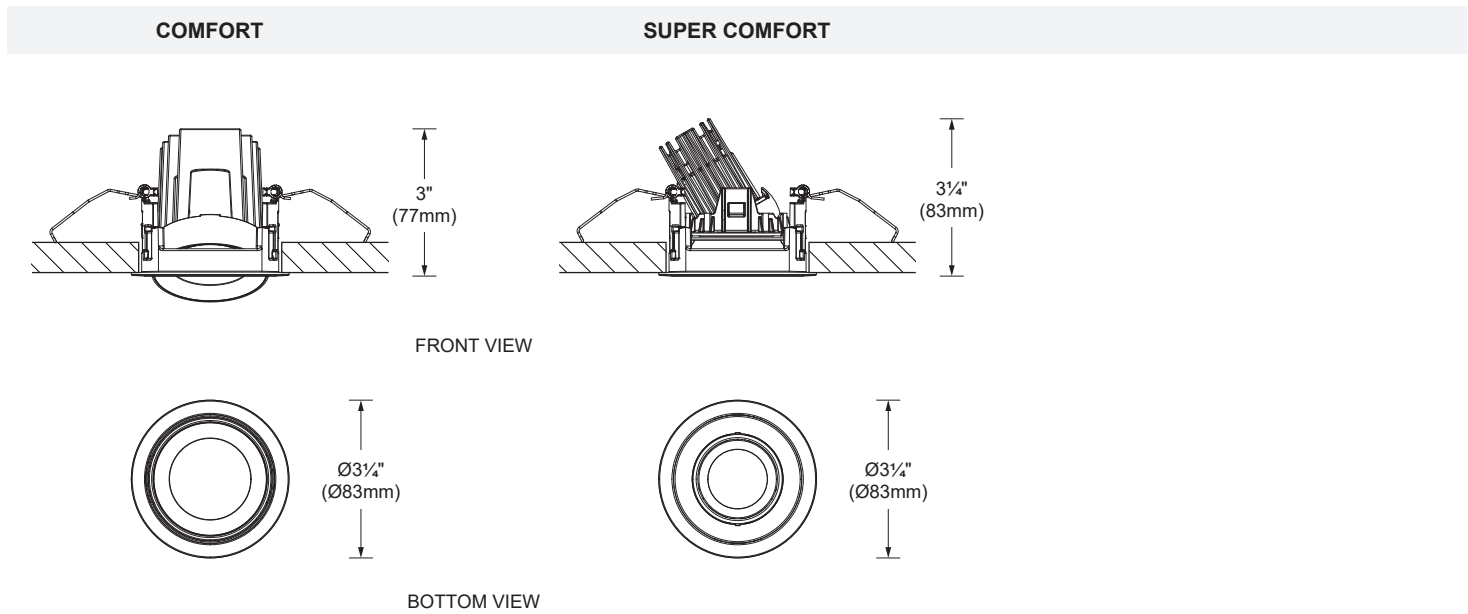

**TRIMLESS MODELS DIMENSIONS**

FIXED OPTIC

**SUPER COMFORT**

**WALL WASHER**

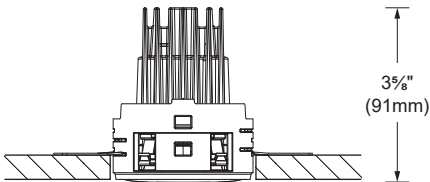
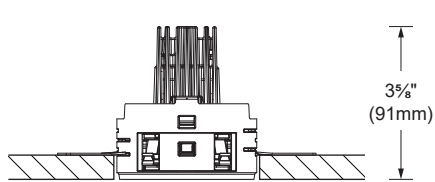

FRONT VIEW

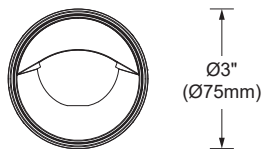

BOTTOM VIEW

ADJUSTABLE OPTIC

**SUPER COMFORT**

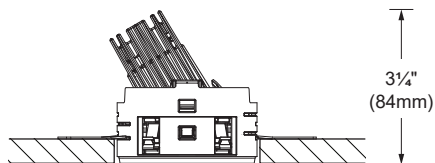

FRONT VIEW



BOTTOM VIEW

**INSTALLATION**

**New construction with housing suitable for insulated ceiling (IC) or Chicago Plenum (CP)**

Housing with hanger bars system for new construction installations. Suitable for insulated ceiling or Chicago Plenum applications. Housing and trim can be shipped separately.

**Ceiling thickness:**

Trim: 1/8" to 7/8" (3mm - 22mm)  
Trimless: 1/2" to 15/16" (12.5mm - 24mm)

**Total weight:**

Trim: 6.33lb (2.87kg)  
Trimless: 6.17lb (2.8 kg)

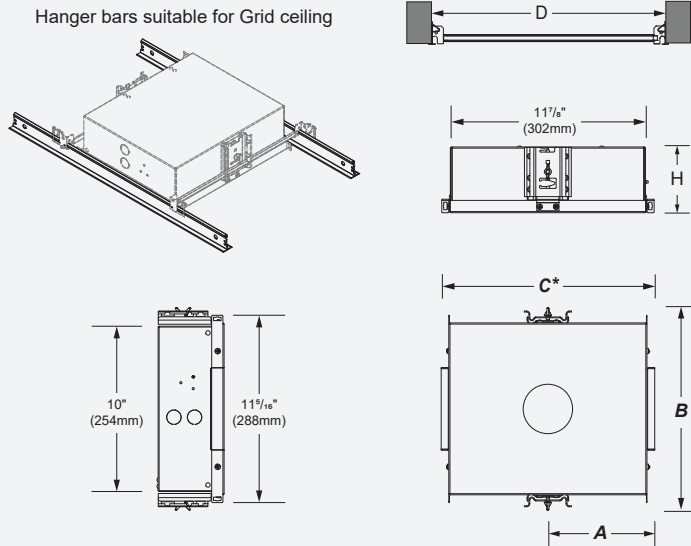

\*Provide a minimum of 1 1/8" (46mm) on each side for the hanger bar fixations

Model	Housing	Cut-out dimensions	Cut-out position (A)	Max Overall dimensions (BxC*)	Hanger bars (D)	Clearance (H)
LASER 75	BI-LAS75-RT-IC/CP-REM	Ø 3" (Ø 75mm)	6 7/16" (164mm)	12 1/4" x 12 15/16" (311 x 328mm)	14 1/4" to 26" (362 to 660mm)	4" (102mm)
	BI-LAS75-RLF-IC/CP-REM					
	BI-LAS75-RLA-IC/CP-REM					

**ACCESSORIES (TO BE ORDERED SEPARATELY)**

Fixture can hold a maximum of 3 accessories at a time.

	PRODUCT CODE	COMFORT FIXED	COMFORT ADJUSTABLE	SUPER COMFORT FIXED
HONEYCOMB LOUVRE	IMY22-04 - Black	<input type="checkbox"/>	<input type="checkbox"/>	<input type="checkbox"/>
DIFFUSER GLASS	IMY23-65	<input type="checkbox"/>	<input type="checkbox"/>	<input type="checkbox"/>
REFRACTOR LENS (for elliptical distribution)	IMY24-24	<input type="checkbox"/>	<input type="checkbox"/>	<input type="checkbox"/>
DECORATIVE RINGS	IMY26-05 - Red	<input type="checkbox"/>	<input type="checkbox"/>	<input type="checkbox"/>
	IMY26-06 - Yellow	<input type="checkbox"/>	<input type="checkbox"/>	<input type="checkbox"/>
	IMY26-16 - Blue	<input type="checkbox"/>	<input type="checkbox"/>	<input type="checkbox"/>
INTERNAL ANTI-GLARE RING	IMY27-04- Black	<input type="checkbox"/>	<input type="checkbox"/>	<input type="checkbox"/>
DECORATIVE CYLINDERS	IMY28-05 - Red	<input type="checkbox"/>	<input type="checkbox"/>	<input type="checkbox"/>
	IMY28-06 - Yellow	<input type="checkbox"/>	<input type="checkbox"/>	<input type="checkbox"/>
	IMY28-16 - Blue	<input type="checkbox"/>	<input type="checkbox"/>	<input type="checkbox"/>
	IMY28-24 - Clear transparent	<input type="checkbox"/>	<input type="checkbox"/>	<input type="checkbox"/>

**PHOTOMETRIC DATA**

**COMFORT  
FIXED**

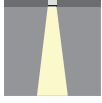

CCT (K)	CRI	LOAD (W)*	OPTIC	LUMENS (lm)	EFFICACY (lm / W)	MAX CANDELA (cd)	MODELS
3000K	90	10.5W	Medium 26°	986	94	4 183	ILAS75RXXX-930-SGFMD
			Wide flood 46°	1 011	96	1 981	ILAS75RXXX-930-SGFWF
			Very wide flood 56°	1 012	96	1 344	ILAS75RXXX-930-SGFVW

\*For products that uses a remote led driver, total system wattage will varies according to the efficacy of the remote led driver selected. For this reason, the load and efficacy values given in the table above refers to the led source only and does not include the led driver consumption. Use multiplier table for other CCT and CRI output data. Efficacy based on IESNA LM-79 test reports.

Medium 26° (3000K, 90CRI)

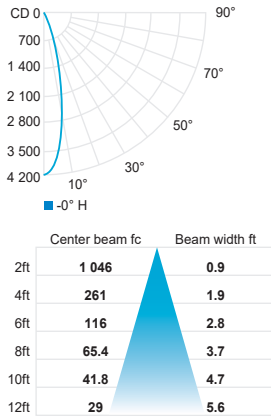

Wide flood 46° (3000K, 90CRI)

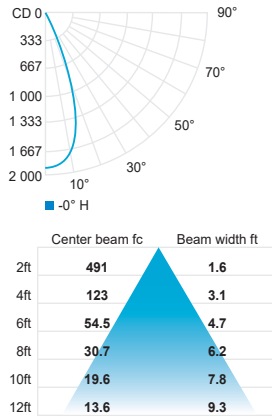

Very wide flood 56° (3000K, 90CRI)

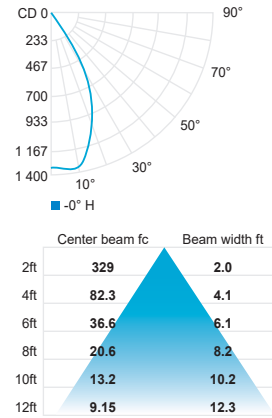

**COMFORT  
ADJUSTABLE**



CCT (K)	CRI	LOAD (W)*	OPTIC	LUMENS (lm)	EFFICACY (lm / W)	MAX CANDELA (cd)	MODELS
3000K	90	10.5W	Spot 16°	948	90	6 149	ILAS75RXXX-930-SGASP
			Medium 26°	973	93	4 232	ILAS75RXXX-930-SGAMD
			Wide flood 44°	986	94	1 973	ILAS75RXXX-930-SGAWF

\*For products that uses a remote led driver, total system wattage will varies according to the efficacy of the remote led driver selected. For this reason, the load and efficacy values given in the table above refers to the led source only and does not include the led driver consumption. Use multiplier table for other CCT and CRI output data. Efficacy based on IESNA LM-79 test reports.

Spot 16° (3000K, 90CRI)

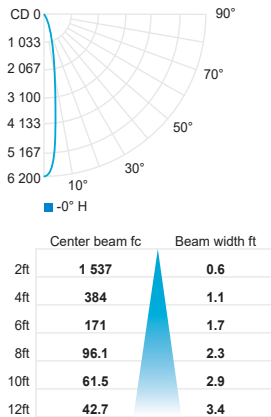

Medium 26° (3000K, 90CRI)

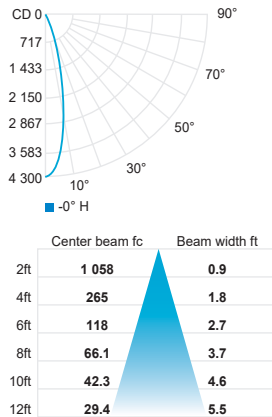

Wide flood 44° (3000K, 90CRI)

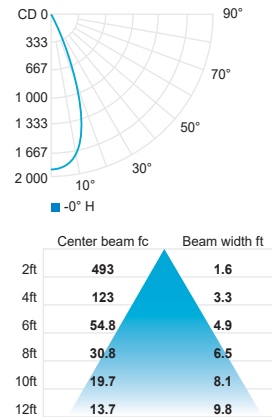

CCT options	2700K	3000K	3500K	4000K
CRI options	90CRI	90CRI	90CRI	90CRI
<b>Multiplier</b>	<b>0.96</b>	<b>1</b>	<b>1.04</b>	<b>1.07</b>

**PHOTOMETRIC DATA**

**SUPER COMFORT FIXED**



CCT (K)	CRI	LOAD (W)*	OPTIC	LUMENS (lm)	EFFICACY (lm / W)	MAX CANDELA (cd)	MODELS
3000K	90	10.5W	Medium 26°	986	94	4 295	ILAS75RXXX-930-SCFMD
			Wide flood 44°	1 026	98	2 084	ILAS75RXXX-930-SCFWF
			Very wide flood 56°	1 000	95	1 343	ILAS75RXXX-930-SCFVW

\*For products that uses a remote led driver, total system wattage will varies according to the efficacy of the remote led driver selected. For this reason, the load and efficacy values given in the table above refers to the led source only and does not include the led driver consumption. Use multiplier table for other CCT and CRI output data. Efficacy based on IESNA LM-79 test reports.

Medium 26° (3000K, 90CRI)

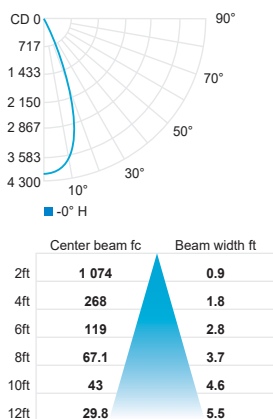

Wide flood 44° (3000K, 90CRI)

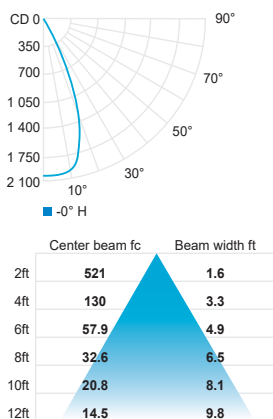

Very wide flood 56° (3000K, 90CRI)

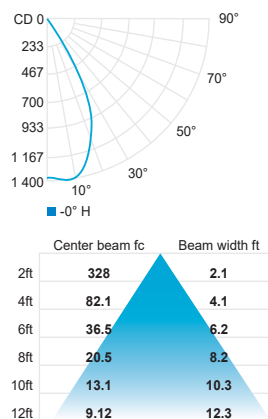

**SUPER COMFORT ADJUSTABLE**



CCT (K)	CRI	LOAD (W)*	OPTIC	LUMENS (lm)	EFFICACY (lm / W)	MAX CANDELA (cd)	MODELS
3000K	90	7.5W	Spot 14°	591	79	5 646	ILAS75RXXX-930-SCASP
			Medium 24°	656	87	3 450	ILAS75RXXX-930-SCAMD
			Flood 38°	648	86	1 595	ILAS75RXXX-930-SCAFL

\*For products that uses a remote led driver, total system wattage will varies according to the efficacy of the remote led driver selected. For this reason, the load and efficacy values given in the table above refers to the led source only and does not include the led driver consumption. Use multiplier table for other CCT and CRI output data. Efficacy based on IESNA LM-79 test reports.

Spot 14° (3000K, 90CRI)

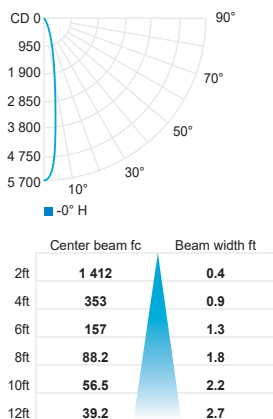

Medium 24° (3000K, 90CRI)

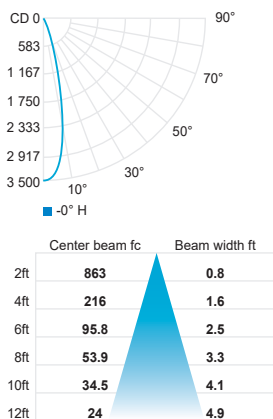

Flood 38° (3000K, 90CRI)

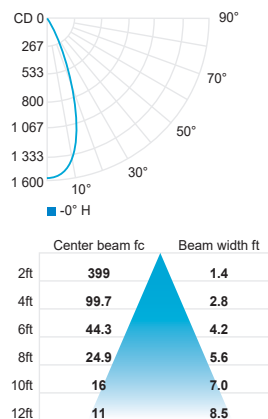

CCT options	2700K	3000K	3500K	4000K
CRI options	90CRI	90CRI	90CRI	90CRI
<b>Multiplier</b>	<b>0.96</b>	<b>1</b>	<b>1.04</b>	<b>1.07</b>



**PHOTOMETRIC DATA**

WALL WASHER



CCT (K)	CRI	LOAD (W)*	OPTIC	LUMENS (lm)	EFFICACY (lm / W)	MAX CANDELA (cd)	MODELS
3000K	90	10.5W	Wall washer	700	67	506	ILAS75RXXX-930-FWW

\*For products that uses a remote led driver, total system wattage will varies according to the efficacy of the remote led driver selected. For this reason, the load and efficacy values given in the table above refers to the led source only and does not include the led driver consumption. Use multiplier table for other CCT and CRI output data. Efficacy based on IESNA LM-79 test reports.

Wall washer (3000K, 90CRI)

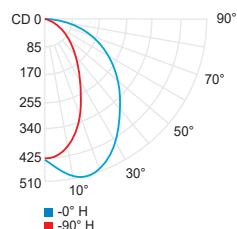

CCT options	2700K	3000K	3500K	4000K
CRI options	90CRI	90CRI	90CRI	90CRI
<b>Multiplier</b>	<b>0.96</b>	<b>1</b>	<b>1.04</b>	<b>1.07</b>

**LED COLOR FIDELITY DATA**

COMFORT • FIXED / ADJUSTABLE  
SUPER COMFORT • FIXED  
WALL WASHER

CRI	CCT	R1	R2	R3	R4	R5	R6	R7	R8	R9	R10	R11	R12	R13	R14	R15	Rf	Rg	Melanopic ratio
90	2700K	93	96	97	93	92	95	93	83	62	89	93	83	93	98	89	92	100	0.478
	3000K	93	95	96	94	93	94	94	86	67	88	94	80	94	97	91	92	100	0.547
	3500K	93	95	95	93	92	93	95	87	67	86	93	75	93	97	91	91	100	0.625
	4000K	92	94	95	92	91	92	95	86	64	85	91	70	92	97	90	90	98	0.718

SUPER COMFORT • ADJUSTABLE

CRI	CCT	R1	R2	R3	R4	R5	R6	R7	R8	R9	R10	R11	R12	R13	R14	R15	Rf	Rg	Melanopic ratio
90	2700K	94	98	99	95	95	98	90	79	54	94	98	90	95	100	88	93	99	0.492
	3000K	95	97	98	96	95	96	93	84	62	92	97	86	95	98	90	93	101	0.555
	3500K	93	96	98	94	93	95	93	82	57	90	95	79	94	98	89	92	98	0.640
	4000K	92	95	96	92	91	93	93	83	57	87	93	73	93	98	89	91	98	0.725